

Specifications

OPERATION

- Lever style handle with temperature indicator on the escutcheon
- Adjustable temperature limit stop to control maximum hot water temperature

FLOW

- Showerhead is limited to 9L/min at 3Bar

CARTRIDGE

- Ceramic disk cartridge

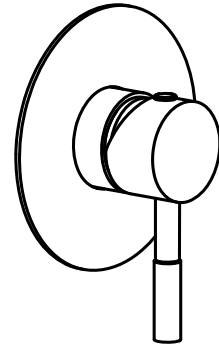

Concealed Shower Set

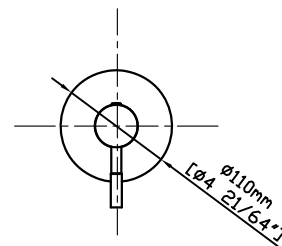
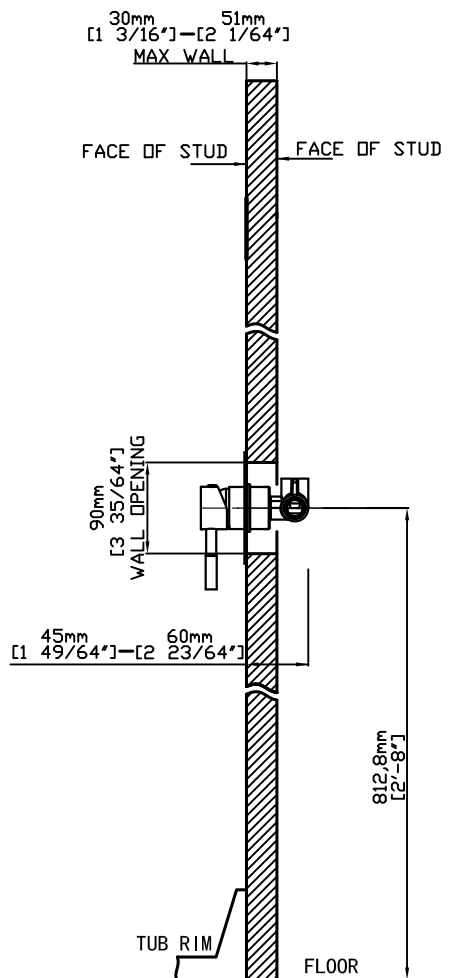

Note: Dimensions are for reference only. Detailed information is in accordance with the final product.

Concealed Shower Set Installation

INSTALLATION MANUAL Tools You Will Need :

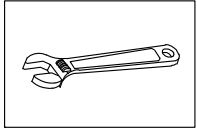

Adjustable wrench

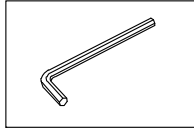

Hexagon wrench

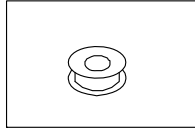

Pipe Tape

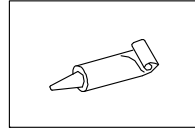

Glue

Notes before installation :

1. Please check that all components are present.
2. Before installation ensure that all feed lines are clear of debris and on/off valve is present.
3. Ensure water pressure is between 0.1-8 BAR (includes combination of hot and cold feed lines).
4. Pictures in the manual are general in content and may not represent exactly your purchased faucet.
If you are having difficulties please contact a professional plumber.
5. If you will be away from home for an extended period you should shut off the main water supply.

Daily maintenance

1. Use a soft cloth and vinegar to remove hard-water spots.
2. Check aerator (if present) regularly for calcium build up are when water stream is not optimum.
3. DO NOT use caustic cleaning products as the use will break down finish and will void the product warranty.
4. Acceptable cleaners include vinegar or mild non-abrasive liquid detergents.
5. If the water pressure appears to be less than optimum remove, inspect, clean or replace aerator.

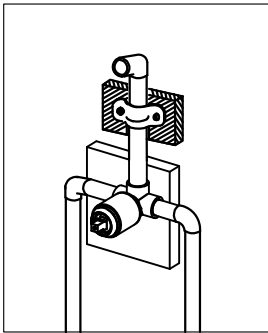

1. Connect the hot&cold inlet tube and outlet tube, then make sure the tube fix stable on the wooden wall.

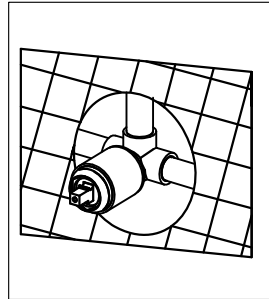

2. Please cut the size of the tile hole according to the size and shape of the protected cover (about 5mm bigger than the protected cover from each side). And please put the tile outside the wooden wall (please noted that we keep the same central point for the tile hole with the protected cover).

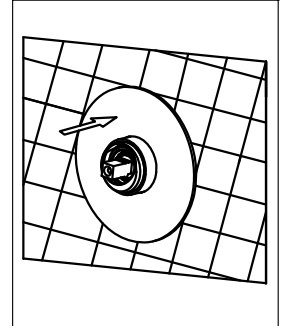

3. Install the steel plate.

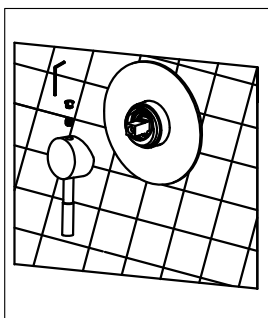

4. Put on the handle, then tight the screw.